



# CLEAR SPANNING

OWAlifetime collection

**OWA**

## System S 6 | clear spanning

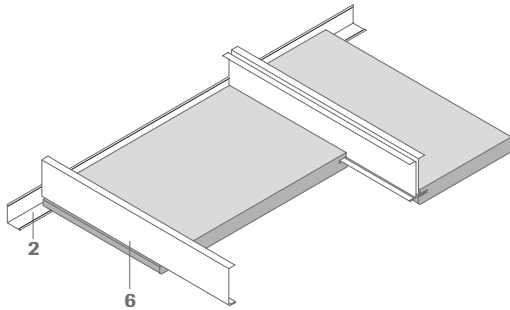

- 1 Wall angle no. 51/20, 20/50 mm, ~ 1.0 mm thickness, pre-drilled
- 2 Wall angle no. 51/25, 25/25 mm, ~ 1.0 mm thickness
- 3 Shadow wall angle no. 56/21, 20/20/20/25 mm, ~ 1.0 mm thickness
- 4 Shadow wall angle no. 50/22, 15/9/15/30 mm, ~ 1.0 mm thickness, pre-drilled
- 5 Z profile no. 19/10
- 6 C profile no. 36 or 36/70 (2 pieces)
- 7 T profile no. 40

### Cross-section:

System S 6a – concealed non demountable

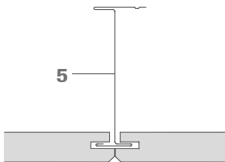

System S 6a – concealed demountable

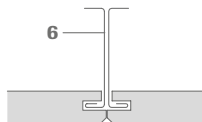

System S 6b – Contura, exposed tee demountable

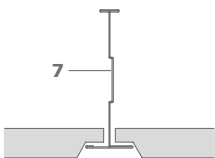

System S 6c – exposed tee demountable

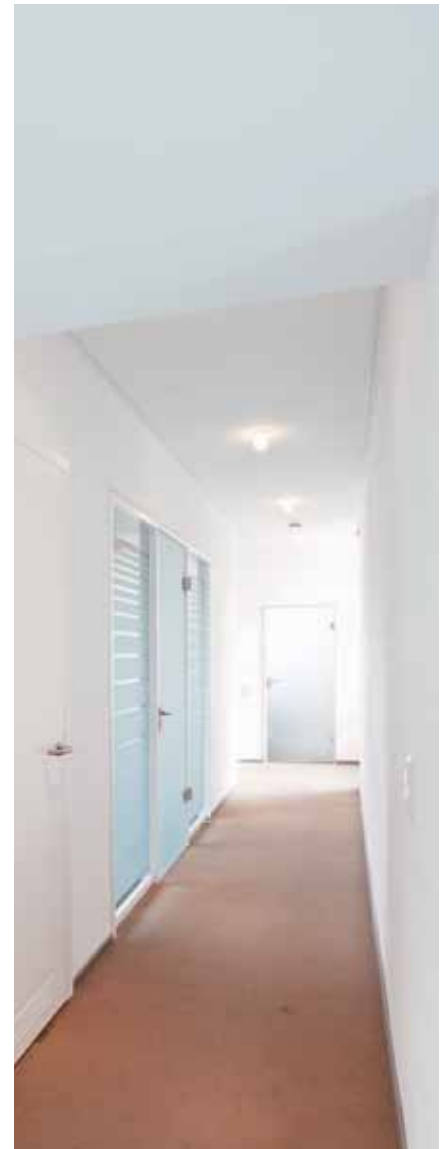
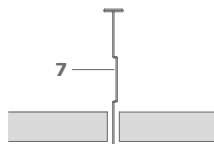

## Technical data | mineral tiles

### Dimensions

Widths: 300 mm, 312.5 mm, 400 mm | lengths: 1200 mm, 1250 mm, 1500\*\* mm, 2000\* mm, 2500\* mm

Other sizes available on request. Subject to minimum quantities and surcharges. See OWAlifetime collection price list.  
\* only conditionally demountable | \*\* depending on design

### Edge details

Short edge

Long edges



S 6a:



S 6b:



S 6c:



### Thickness

Approx. 15 mm (OWAcoustic® premium)

### Reaction to fire

A2-s1,d0 in accordance with EN 13501-1

### Resistance to fire

System S 6a: certification for fire protection is available  
Systems S 6b and S 6c have no certification.

### Metal suspensions

All metal components listed are galvanized steel or white coated galvanized steel respectively. For further details and colours please consult OWAlifetime collection price list.

### Suspension depth

S 6a: 180 - 200 mm  
S 6b and S 6c: 100 - 120 mm

### Wall perimeter:

for system S 6a and S 6c

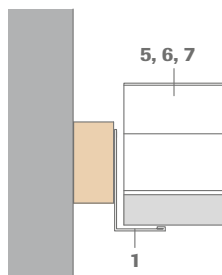
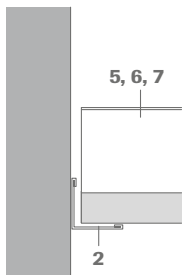

for system S 6 b

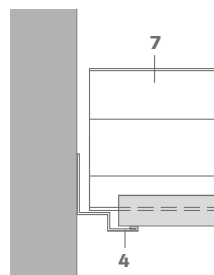

With systems S 6b and S 6c the metal sections supporting the long edges of the OWAoustic® ceiling tiles are loose laid onto the perimeter wall angles. To ensure that there is no lateral movement of the installed tiles it is recommended that every 5th supporting section is secured to the walls or structural soffit. Profiles no. 45 can be secured with angle bracket no. 8017. For further examples of wall perimeters and installation details see OWA-Installation Guide 801 E.

### Installation example:

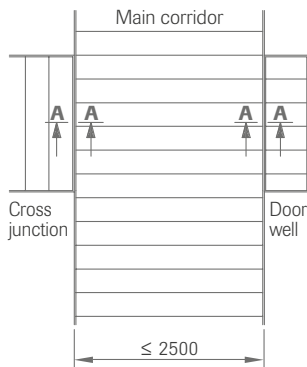

The perimeter wall details in the main corridor should be installed for best optical effect. At corridor cross junctions and in door wells it is also possible to make a perfect transition between the ceiling surfaces. Other junction connections are possible, for example with Bandraster profiles which are extremely rigid and can provide security against pressure and lateral thrust.

#### Section A - A

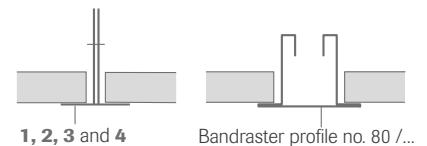

### Light fixtures:

OWA can supply compatible light fixtures for this system.

For details of performance, installation and fire resistance please see OWA-brochure no. 9630 e and OWA-Installation Guide no. 801 E.

### Profile span widths: measures in mm

Item no.	Profile description	Stalk height	Material thickness	Up to 312.5 mm		Up to 400 mm	
				15 mm	20 mm	15 mm	20 mm
20	Z profile (galv.)	21	0.5	1490	1400	1410	1330
22	Z profile (galv.)	33	0.5	1910	1800	1810	1700
69	Z profile (galv.)	45	0.5	2290	2160	2170	2040
19	Z profile (galv.)	70	0.5	2500	2500	2500	2500
19/10	Z profile (galv.)	70	0.6	2500	2500	2500	2500
19/45	Z profile (galv.)	45	0.6	2310	2180	2190	2070
45	Main tee (white)	38	2 x 0.3	1940	1820	1840	1730
40	Main tee (white)	70	0.6	2500	2500	2500	2500
37	L profile (galv.)	25	0.6	1600	1510	1520	1430
36	C profile (galv.)	50	0.6	2500	2500	2500	2500
36/70	C profile (galv.)	70	0.6	2500	2500	2500	2500

The above OWA-span chart restricts its recommendations to a maximum section deflection of 2.5 mm for best optical effect. For special situations, for example the addition of wool overlays, light fittings or cold roofs, high humidity and open areas etc., see OWA-Installation Guide 801 E.

**Important!** In areas requiring fire protection, main tee no. 45 should be used.

## Weight per m<sup>2</sup>:

**Suspension approx. 0.90 - 3.20 kg**

Tile 15 mm, approx. 4.5 kg/m<sup>2</sup>

Tile 20 mm, approx. 6.0 kg/m<sup>2</sup>

## System description:

### Clear spanning OWAconstruct® System S 6a (concealed system, tiles demountable/non-demountable)

#### Quality Statement:

OWAacoustic mineral panels are free from harmful materials such as asbestos and formaldehyde. A statement from the German institute for Building Technology is available. The mineral wool used in these panels is biodegradable. The criterions of the zero-ranking as a carcinogenic material in the chemical prohibition ordinance (§ 1 appendix) section 23 bio-persistent fibres are complied with and therefore carries the "RAL-Seal of mineral wool" guarantees.

**Installation** should be carried out in accordance with the information contained in system leaflet S 6a and OWA-Installation Guide no. 801 E.  
All components are CE labelled.

#### Component list:

OWAconstruct Z profile no. 19/10 (tiles non-demountable) or C profile no. 36/70 (2 pieces per joint – tiles demountable), galvanized  
OWAconstruct wall angles no. 51/20, no. 51/25, no. 56/21 or no. 50/22, visible surfaces white painted

Mineral tiles according to EN 13964 and DIN 18177:

Air Permeability Class PM 1  
Formaldehyde FH Class 1  
TVOC Class 1

### Clear spanning OWAconstruct® System S 6b – Contura edge (exposed system, tiles demountable)

#### Quality Statement:

as for system S 6a

**Installation** should be carried out in accordance with the information contained in system leaflet S 6b and OWA-Installation Guide no. 801 E.  
All components are CE labelled.

#### Component list:

OWAconstruct T profile no. 45 or T profile no. 40, visible surfaces white painted  
OWAconstruct wall angle no. 50/22, visible surfaces white painted  
OWAconstruct Contura-filler block no. 42/24

### Clear spanning OWAconstruct® System S 6c (exposed system, tiles demountable)

#### Quality Statement:

as for system S 6a

**Installation** should be carried out in accordance with the information contained in system leaflet S 6c and OWA-Installation Guide no. 801 E.  
All components are CE labelled.

#### Component list:

OWAconstruct T profile no. 45 or T profile no. 40, visible surfaces white painted  
OWAconstruct shadow wall angles no. 51/20, no. 51/25, no. 56/21 or no. 50/22, visible surfaces white painted

## Product Warranties

The information provided in this leaflet is based on the standards and data available at the time of publication. Any performance, warranties or guarantees provided, expressed or implied, are subject to the exclusive use of OWA components and the installation of those components in accordance with our recommendations. Failure to adhere to these conditions will result in the invalidation of any performance claims, warranties or guarantees and rejection of any liability. OWA reserves the right to make any technical improvements to the products, systems or services without prior notice. **All goods and services are supplied in accordance with our current Terms and Conditions of Sale.** Errors excepted!



# OWA

Odenwald Faserplattenwerk GmbH  
Dr.-F.-A.-Freundt-Straße 3 | 63916 Amorbach  
tel +49 93 73.2 01-0 | info@owa.de  
www.owa-ceilings.com

Brochure S 6 e  
081400